

Potain Igo 10

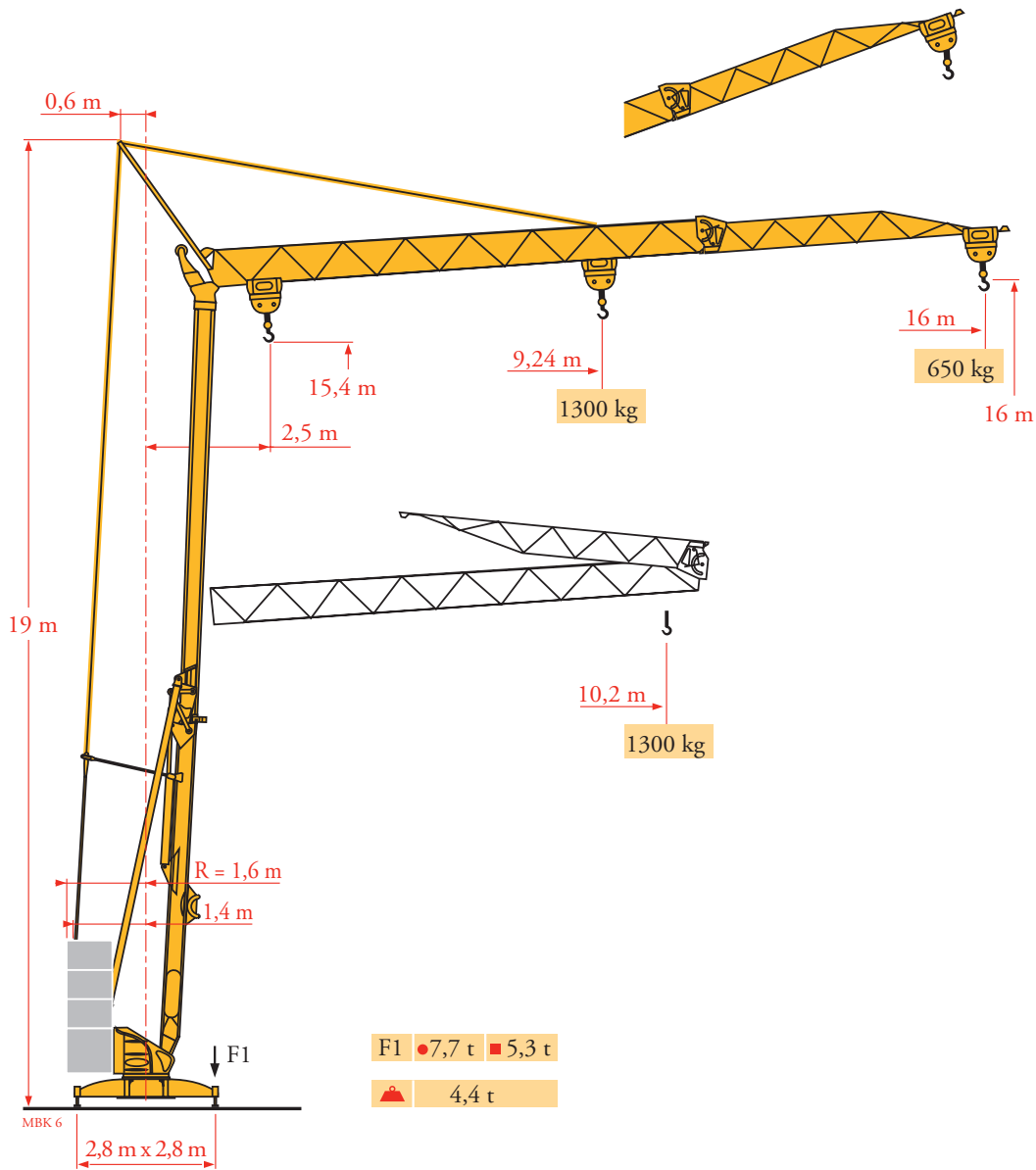

Courbes de charges
 Lastkurven
 Load diagrams
 Curvas de cargas
 Curve di carico
 Curva de cargas
 Диаграммы грузоподъемностей

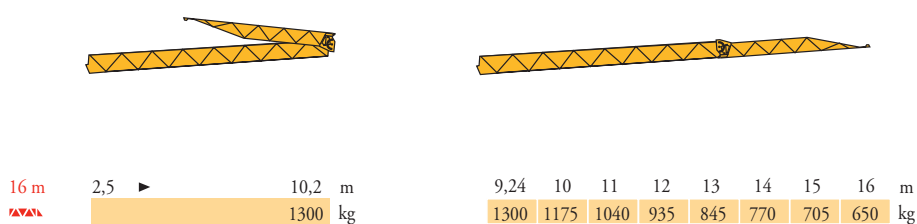







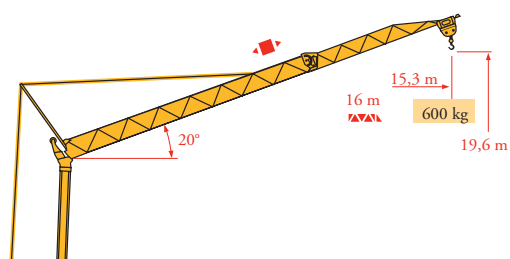



















MBK 6



Flèche relevée
 Ausleger in Steilstellung
 Luffing jib
 Flecha izada
 Braccio impennato
 Lança inclinada
 Маховая стрела

































MBK 4



FR	DE	EN	ES	IT	PT	RU
   	   	   	   	   	   	   
Chariot distributeur Réactions en service Réactions hors service A vide sans lest (ni train de transport) avec flèche et hauteur maximum.	Verfahrbare Laufkatze Reaktionskräfte in Betrieb Reaktionskräfte außer Betrieb Ohne Last, Ballast (und Transportachse), mit Maximalausleger und Maximalhöhe.	Traversing trolley Reactions in service Reactions out of service Without load, ballast (or transport axles), with maximum jib and maximum height.	Carro distribuidor Reacciones en servicio Reacciones fuera de servicio Sin carga, sin lastre, (ni tren de transporte), flecha y altura máxima.	Carrellino distributore Reazioni in servizio Reazioni fuori servizio A vuoto, senza zavorra (ne assali di trasporto) con braccio massimo e altezza massima.	Carro distribuidor Reações em serviço Reações fora de serviço Sem carga (nem trem de transporte)- sem lastro com lança e altura máximas.	Грузовая тележка Реакции при работе Реакции в покое Вес без груза, балласта (или транспортных осей), с максимальной длиной стрелы и максимальной высотой.

Mécanismes
Antriebe
Mechanisms
Mecanismos
Meccanismi
Mecanismos
Механизмы

MBK 6

				ch - PS hp	kW	
	6 LVF 7 Optima	230 V 	m/min	 3,5  7  11,5  17  32  18  40  18  40	3,3	2,4
		20 A 	kg	1300 1300 1300 600 500		
		230 V 	m/min	 3,5  11,5  11,5  17  32  27  40  27  40	5,2	3,8
		32 A 	kg	1300 1300 1300 600 500		
		400 V 	m/min	 3,5  11,5  19  33  40	5,5	4
			kg	1300 1300 1300 600 500		
	1 D1 V3	-	m/min	24	1,5	1,1
	RVF 20	-	w/min U/min rpm	0 → 1	1,5	1,1
CEI 38  IEC 38			kVA			
230 V(+6% -10%) 50 Hz  400 V(+6% -10%) 50 Hz			230 V 20 A : 4,6 kVA 230 V 32 A : 7,4 kVA 400 V : 9,5 kVA			

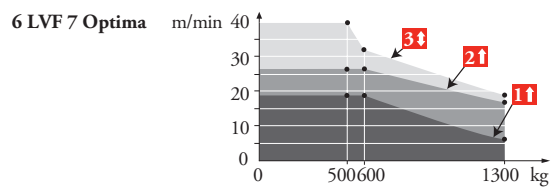



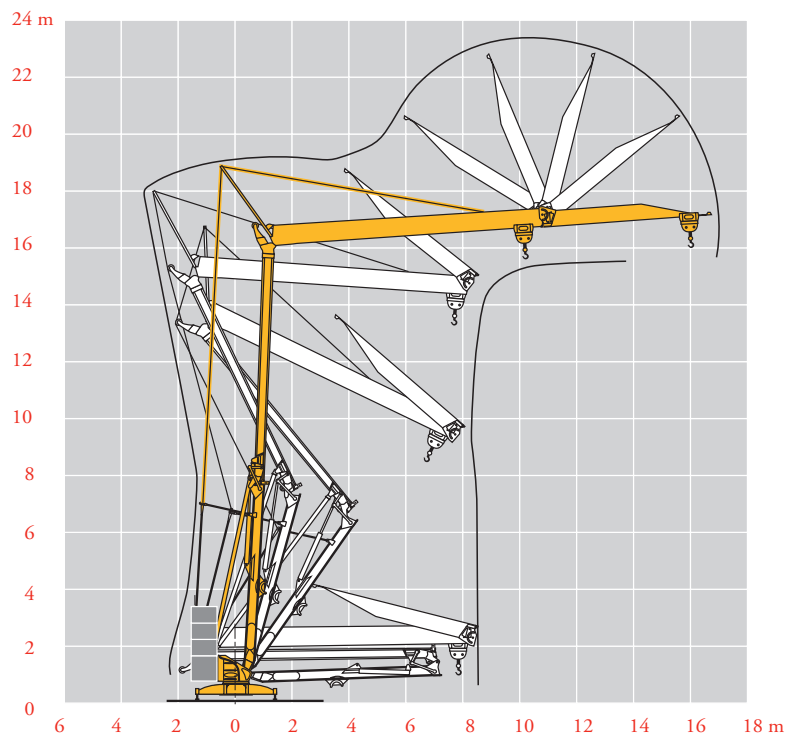

Montage
Montage
Erection
Montaje
Montaggio
Montagem
Монтаж

MBK 4



FR

-  Levage
-  Distribution
-  Orientation
-  50 Hz Monophasé

DE

- Heben
- Katzfahren
- Schwenken
- 50 Hz Einphasige

EN

- Hoisting
- Trolleying
- Slewing
- 50 Hz Single phase

ES

- Elevación
- Distribución
- Orientación
- 50 Hz Monofásica

IT

- Sollevamento
- Distribuzione
- Rotazione
- 50 Hz Monofase

PT

- Elevação
- Distribuição
- Rotação
- 50 Hz monofásica

RU

- Подъем
- Перемещение каретки
- Поворот
- Однофазное напряжение 50Hz

Transport
 Transport
 Transport
 Transporte
 Transporte
 Transporte
 Транспортировка

MBK 5

- DS30/S30 ○
- DS51/S70 ○
- DS61/S80 ○
- DS61/S120 ○
- DS61/S125
- DS65/S65
- DJ80/S120 ○
- DJ80/S125
- DJ100/S120 ○
- DJ105/S125

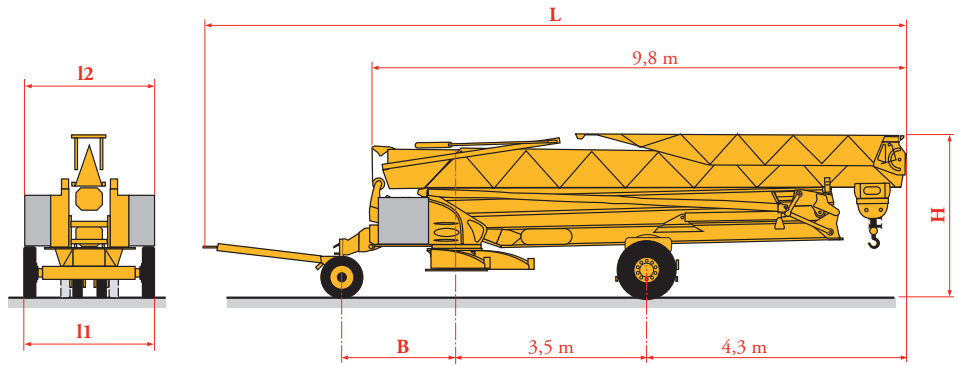

	L (m)	B (m)	H (m)	l1/l2 (m)
DS30/S30	11,46	1,98	2,68	1,73
DS51/S70	12,12	2,32	2,65/2,8	2,1/2,4
DS61/S80	12,4	2,08	2,65/2,8	1,82/2,4
DS61/S120	12,4	2,08	2,65/2,8	2,4
DS61/S125	12,4	2,08	2,65/2,8	2,4
DS65/S65	12,4	1,98	2,65/2,8	1,98/2,4
DJ80/S120	12,4	2,08	2,65/2,8	2,4
DJ80/S125	12,4	2,08	2,65/2,8	2,4
DJ100/S120	12,4	2,08	2,65/2,8	2,4
DJ105/S125	12,4	2,08	2,65/2,8	2,4

- **FR**
Chantier
- **DE**
Baustelle
- **EN**
Site
- **ES**
Obra
- **IT**
Cantiere
- **PT**
Estaleiro
- **RU**
По строительной площадке



Document commercial non contractuel. Pour toute information technique se référer à la notice correspondante.

Unverbindliches Vertriebsdokument. Für technische Informationen, siehe die entsprechenden Anweisungen.

This commercial document is not legally binding. For any technical information, please refer to the corresponding instructions.

Documento commercial no contractual. Para cualquier información técnica, ver la noticia correspondiente.

Documento commerciale non vincolante, per tutte le informazioni tecniche fare riferimento al catalogo istruzioni.

Documento comercial não contratual. Para qualquer informação técnica complementar consultar as respectivas instruções.

Этот коммерческий документ не является юридически обязательным. Для получения технической информации, см. соответствующие инструкции.



Manitowoc - Americas - World Headquarters
 2400 S. 44th Street • Manitowoc • WI 54220 USA
 Tel: +1 920 684 4410 • Fax: +1 920 652 9778

Manitowoc - Europe, Middle East & Africa
 Manitowoc France SAS
 18, rue de Charbonnières B.P. 173 • 69132 ECULLY Cedex • FRANCE
 Tel: +33 (0)4 72 18 20 20 • Fax: +33 (0)4 72 18 20 00

Manitowoc - Asia Pacific
 16F Xu Hui Yuan Building,
 1089 Zhongshan No.2 Road (S) • Shanghai 200030 China
 Tel: +86 21 6457 0066 • Fax: +86 21 6457 4955